

**ZAR** mini



**RIB PRO RIB LUX AIR ALU FUN**



# LUX Rider

# LUX rider 18

**NEW**

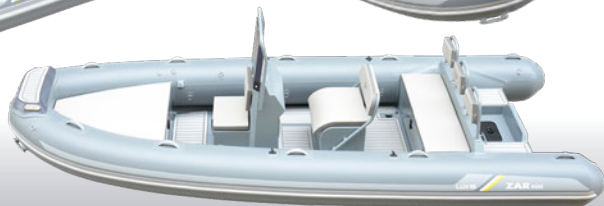
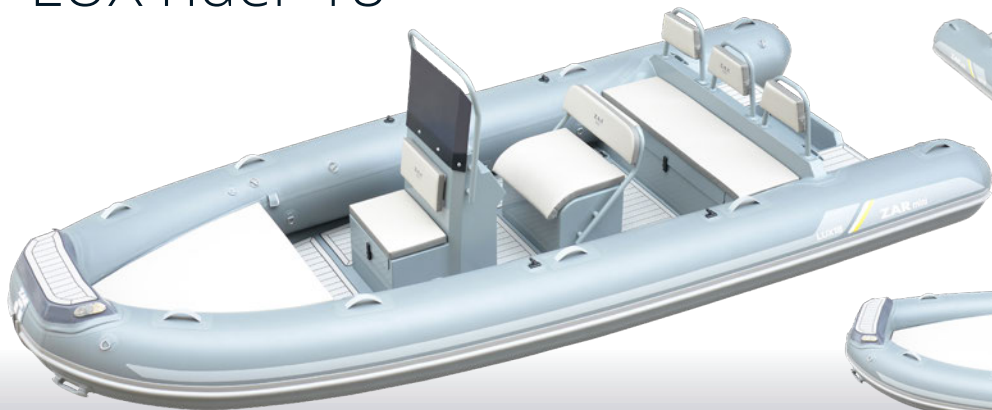

CE



550 cm  
(18' 5")



450 cm  
(14' 9")



235 cm  
(7' 9")



131 cm  
(4' 4")



51 cm  
(21")



ca. 395 kg\*  
(870 Lbs\*)



1100 kg  
(2424 Lbs)



10



6



max  
85kw (115HP)



rec.  
74w (100HP)



max  
170 kg  
(375 Lbs)

# LUX 16 Rider

**NEW**



CE



500 cm  
(16' 5")



395 cm  
(12' 11")



224 cm  
(7' 5")



118 cm  
(3' 10")



51 cm  
(21")



ca. 295 kg\*  
(650 Lbs\*)



1000 kg  
(2200 Lbs)



9



6



max  
74kw (100HP)



rec.  
59kw (80HP)



max 170 kg  
(375 Lbs)

# LUX 15 Rider

**NEW**

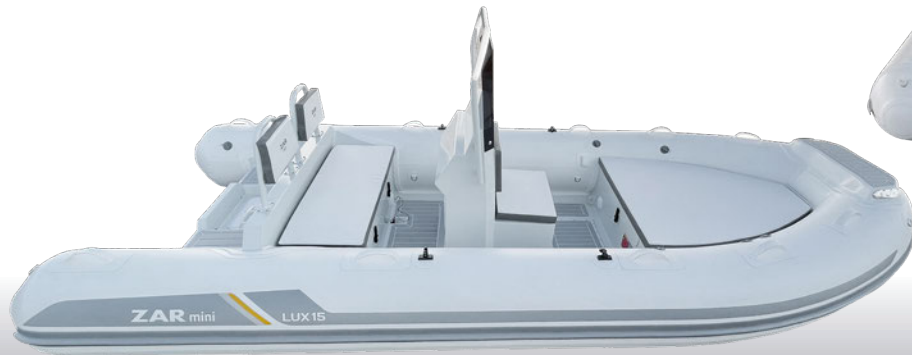

CE



460 cm  
(15' 2")



360 cm  
(11' 10")



210 cm  
(6' 11")



107 cm  
(3' 6")



50 cm  
(21")



ca. 255 kg\*  
(562 Lbs\*)



900 kg  
(1984 Lbs)



8



6



max  
52kw (70HP)



rec.  
37,5kw (50HP)



max 120 kg  
(265 Lbs)



YAMAHA

ZAR mini

LUX15

N-M130

# LUX 14 Rider

**NEW**



CE



420 cm  
(13' 9")



316 cm  
(10' 4")



210 cm  
(6' 11")



105 cm  
(3' 5")



51 cm  
(21")



ca. 235 kg\*  
(518 Lbs\*)



850 kg  
1870 Lbs



8



4



max  
44kw (60HP)



rec.  
29,4kw (40HP)



max 110 kg  
(242 Lbs)



# LUX Tender



# LUX 13 Tender



CE



390 cm  
(12' 10")



300 cm  
(9' 10")



191 cm  
(6' 3")



92 cm  
(3')



49 cm  
(19")



ca. 148 kg\*  
(305 Lbs\*)



700 kg  
(1322 Lbs)



6



4



max  
37kw (50HP)



rec.  
29kw (40HP)



max  
110 kg  
(242 Lbs)

# LUX 12 Tender



CE



350 cm  
(11' 5")



256 cm  
(8' 5")



190 cm  
(6' 3")



92 cm  
(3')



49 cm  
(19")



ca. 138 kg\*  
(305 Lbs\*)



600 kg  
(1322 Lbs)



5



4



max  
30kw (40HP)



rec.  
22,4kw (30HP)



max  
110 kg  
(242 Lbs)



MERCURY

ZAR mini

LUX 12

ZAR  
ITALY



**RIB PRO**

# RIB 18 SC / RIB 18 DL



CE



550 cm  
(18' 1")



435 cm  
(14' 3")



224 cm  
(7' 5")



118 cm  
(3' 10")



52 cm  
(21")



ca. 310 kg\*  
(705 Lbs\*)



1000 kg  
(2200 Lbs)



10



6



max  
85kw (115HP)



rec.  
66kw (90HP)



max  
170 kg  
(375 Lbs)

# RIB 16 SC



CE



500 cm  
(16' 5")



399 cm  
(13' 2")



224 cm  
(7' 5")



118 cm  
(3' 10")



52 cm  
(21")



ca. 320 kg\*  
(705 Lbs\*)



1000 kg  
(2200 Lbs)



10



6



max  
66kw (90HP)



rec.  
44kw (60HP)



max  
170 kg  
(375 Lbs)

# RIB 16 SC

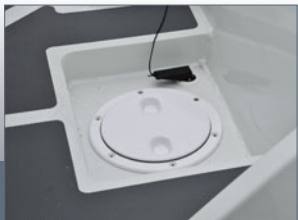

# RIB 16 DL



CE



500 cm  
(16' 5")



399 cm  
(13' 2")



224 cm  
(7' 5")



118 cm  
(3' 10")



52 cm  
(21")



ca. 250 kg\*  
(551 Lbs\*)



1000 kg  
(2200 Lbs)



10



6



max  
66kw (90HP)



rec.  
44kw (60HP)



max  
170 kg  
(375 Lbs)





ZAR  
16

1-1169

RIB 16

ZAR mini

# RIB 15 Tender

**NEW**



CE



460 cm  
(15' 2")



363 cm  
(11' 11")



210 cm  
(6' 11")



105 cm  
(3' 6")



51 cm  
(21")



ca. 171 kg\*  
(377 Lbs\*)



900 kg  
1984 Lbs



9



6



max  
44kw (60HP)



rec.  
37,5kw (50HP)



max  
120 kg  
(265 Lbs)

# RIB 15 DL



CE



460 cm  
(15' 2")



363 cm  
(11' 10")



210 cm  
(6' 11")



105 cm  
(3' 5")



51 cm  
(21")



ca. 171 kg\*  
(377 Lbs\*)



900 kg  
(1984 Lbs)



9



6



max  
44kw (60HP)



rec.  
37,5kw (50HP)



max  
120 kg  
(265 Lbs)

# RIB 14 DL

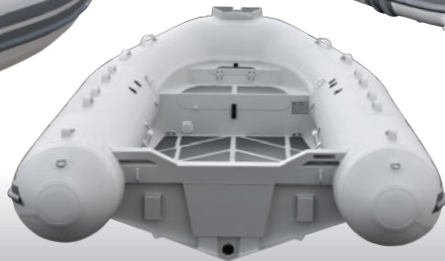

CE



420 cm  
(13' 9")



323 cm  
(10' 7")



210 cm  
(6' 11")



105 cm  
(3' 5")



51 cm  
(21")



ca. 137 kg\*  
(302 Lbs\*)



850 kg  
1870 Lbs



8



4



max  
37,5kw (50HP)



rec.  
22,4kw (30HP)



max  
110 kg  
(242 Lbs)

# RIB 13 DL

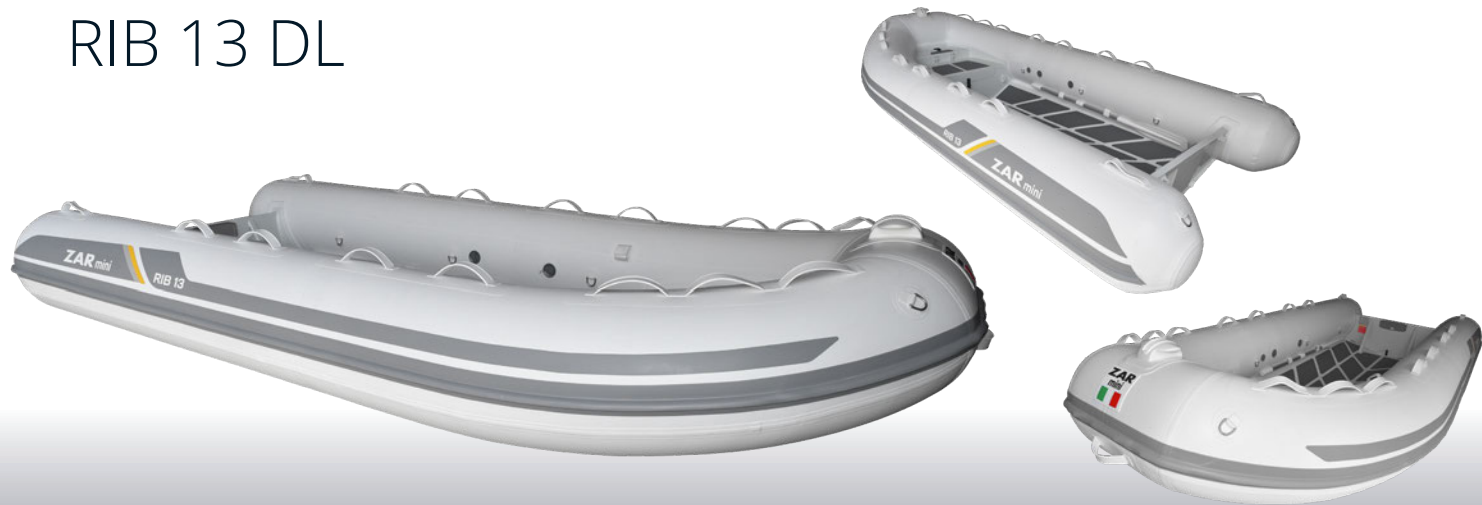

CE



380 cm  
(12' 6")



289 cm  
(9' 6")



183 cm  
(6')



88 cm  
(2' 10")



45 cm  
(18")



ca. 91 kg\*  
(201 Lbs\*)



690 kg  
(1521 Lbs)



7



4



max  
22,4kw (30HP)



rec.  
14,7kw (20HP)



max  
90 kg  
(198 Lbs)

# RESCUE RIBs

RESCUE version available for all models



# RIB 16 Heavy Duty



CE



500 cm  
(16' 5")



399 cm  
(13' 2")



224 cm  
(7' 5")



118 cm  
(3' 10")



52 cm  
(21")



ca. 297 kg\*  
(655 Lbs\*)



1000 kg  
(2200 Lbs)



10



6



max  
74kw (100HP)



rec.  
44kw (60HP)



max  
170 kg  
(375 Lbs)



RIB 10

ZAR mini

RIB



# RIB 12 DL



CE



360 cm  
(11' 10")



272 cm  
(8' 11")



171 cm  
(5' 7")



80 cm  
(2' 7")



43 cm  
(17")



ca. 79 kg\*  
(174 Lbs\*)



600 kg  
(1320 Lbs)



6



4



max  
14,7kw (20HP)



rec.  
7,4kw (10HP)



max  
55 kg  
(122 Lbs)

# RIB 11 DL



CE



330 cm  
(10' 10")



246 cm  
(8' 1")



171 cm  
(5' 7")



80 cm  
(2' 7")



43 cm  
(17")



ca. 74 kg\*  
(163 Lbs\*)



550 kg  
(1210 Lbs)



5



4



max  
14,7kw (20HP)



rec.  
7,4kw (10HP)



max  
55 kg  
(122 Lbs)

# RIB 10 DL



CE



300 cm  
(9' 11")



220 cm  
(7' 3")



171 cm  
(5' 7")



80 cm  
(2' 7")



43 cm  
(17")



ca. 67 kg\*  
(148 Lbs\*)



500 kg  
(1100 Lbs)



5



4



max  
14,7kw (20HP)



rec.  
7,4kw (10HP)



max  
55 kg  
(122 Lbs)

# RIB 9 DL



CE



270 cm  
(8' 11")



190 cm  
(6' 3")



171 cm  
(5' 7")



80 cm  
(2' 7")



43 cm  
(17")



ca. 59 kg\*  
(120 Lbs\*)



450 kg  
(990 Lbs)



4



4



max  
11kw (15HP)



rec.  
3,7kw (5HP)



max  
51 kg  
(113 Lbs)

# RIB 8 DL



CE



240 cm  
(7' 11")



160 cm  
(5' 3")



165 cm  
(5' 5")



80 cm  
(2' 7")



40 cm  
(16")



ca. 54 kg\*  
(119 Lbs\*)



350 kg  
(770 Lbs)



3



4



max  
4,4kw (6HP)



rec.  
3,7kw (5HP)



max  
30 kg  
(66 Lbs)



**MERCURY**  
4

RIB 8





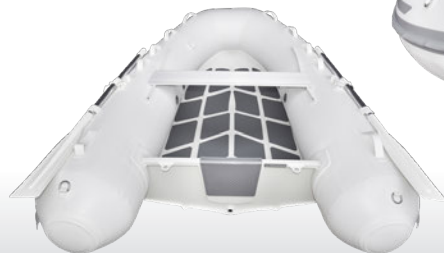







**RIB LITE**

# RIB LITE (8-11)



CE



												
<b>RIB 8 LITE</b>	240 cm (7' 11")	160 cm (5' 3")	165 cm (5' 5")	80 cm (2' 7")	40 cm (16")	ca. 34 kg* (75 Lbs*)	290 kg (639 Lbs)	3	4	max 3,0kw (4HP)	rec. 2,2kw (3HP)	max 30 kg (66 Lbs)
<b>RIB 9 LITE</b>	270 cm (8' 11")	190 cm (6' 3")	171 cm (5' 7")	80 cm (2' 7")	43 cm (17")	ca. 39 kg* (86 Lbs*)	340 kg (750 Lbs)	4	4	max 4,4kw (6HP)	rec. 3,7kw (5HP)	max 30 kg (66 Lbs)
<b>RIB 10 LITE</b>	300 cm (9' 11")	220 cm (7' 3")	171 cm (5' 7")	80 cm (2' 7")	43 cm (17")	ca. 44 kg* (97 Lbs*)	390 kg (850 Lbs)	5	4	max 5,9kw (8HP)	rec. 4,4kw (6HP)	max 40 kg (88 Lbs)
<b>RIB 11 LITE</b>	330 cm (10' 10")	246 cm (8' 1")	171 cm (5' 7")	80 cm (2' 7")	43 cm (17")	ca. 49 kg* (108 Lbs*)	420 kg (926 Lbs)	5	4	max 7,4kw (10HP)	rec. 5,9kw (8HP)	max 40 kg (88 Lbs)



**AIR-ALU-FUN**



# AIR 7 • AIR 8 • AIR 9 • AIR 10



CE



**AIR 7**

210 cm  
(6' 11")

140 cm  
(4' 7")

155 cm  
(5' 1")

79 cm  
(2' 6")

40 cm  
(16")

ca. 30 kg\*  
(66 Lbs\*)

350 kg  
(770 Lbs)

3

3 + 2

max  
4,4kw (6HP)

rec.  
3,7kw (5HP)

max  
35 kg  
(77 Lbs)

120x55x30 cm  
(47"x22"x12")

**AIR 8**

240 cm  
(7' 11")

162 cm  
(5' 4")

155 cm  
(5' 1")

79 cm  
(2' 6")

40 cm  
(16")

ca. 30 kg\*  
(66 Lbs\*)

350 kg  
(770 Lbs)

3

3 + 2

max  
4,4kw (6HP)

rec.  
3,7kw (5HP)

max  
35 kg  
(77 Lbs)

120x55x30 cm  
(47"x22"x12")

**AIR 9**

270 cm  
(8' 11")

184 cm  
(6' 1")

170 cm  
(5' 7")

88 cm  
(2' 9")

44 cm  
(17")

ca. 40 kg\*  
(88 Lbs\*)

450 kg  
(990 Lbs)

4

3 + 2

max  
11kw (15HP)

rec.  
7,4kw (10HP)

max  
51 kg  
(113 Lbs)

124x53x33 cm  
(49"x22"x12")

**AIR 10**

300 cm  
(9' 11")

206 cm  
(6' 9")

170 cm  
(5' 7")

88 cm  
(2' 9")

44 cm  
(17")

ca. 55 kg\*  
(121 Lbs\*)

500 kg  
(1100 Lbs)

5

3 + 2

max  
14,7kw (20HP)

rec.  
11kw (15HP)

max  
55 kg  
(122 Lbs)

125x62x30 cm  
(49"x25"x12")

# ALU 9 • ALU 10 • ALU 11 • ALU 12



CE



Model	Length	Width	Depth	Height	Diameter	Weight	Additional Weight	Capacity	O <sub>2</sub>	Max Motor	Rec. Motor	Max Weight	Storage
ALU 9	270 cm (8' 11")	185 cm (6' 1")	170 cm (5' 7")	82 cm (2' 8")	44 cm (17")	ca. 30 + 20 kg* (66 + 44 Lbs*)	450 kg (990 Lbs)	4	3 + 2	max 11kw (15HP)	rec. 7,4kw (10HP)	max 51 kg (113 Lbs)	125x52x32 cm + 106x69x12 cm 49"x20"x13" + 42"x27"x5"
ALU 10	300 cm (9' 11")	212 cm (7')	170 cm (5' 7")	82 cm (2' 8")	44 cm (17")	ca. 30 + 25 kg* (66 + 55 Lbs*)	500 kg (1100 Lbs)	5	3 + 2	max 14,7kw (20HP)	rec. 11kw (15HP)	max 55 kg (121 Lbs)	125x52x32 cm + 106x62x15 cm 49"x20"x13" + 42"x24"x6"
ALU 11	330 cm (10' 10")	240 cm (7' 11")	170 cm (5' 7")	82 cm (2' 8")	44 cm (17")	ca. 34 + 29 kg* (75 + 64 Lbs*)	550 kg (1210 Lbs)	6	3 + 1	max 14,7kw (20HP)	rec. 14,7kw (20HP)	max 55 kg (121 Lbs)	125x52x32 cm + 106x68x15 cm 49"x20"x13" + 42"x27"x6"
ALU 12	360 cm (11' 10")	258 cm (8' 6")	195 cm (6' 5")	99 cm (3' 3")	48 cm (19")	ca. 44 + 36 kg* (97 + 79 Lbs*)	750 kg (1650 Lbs)	7	4 + 1	max 18,4kw (25HP)	rec. 14,7kw (20HP)	max 82 kg (181 Lbs)	155x62x35 cm + 132x70x15 cm 61"x24"x14" + 52"x25"x7"

# ALU 13 • ALU 14 • ALU 15

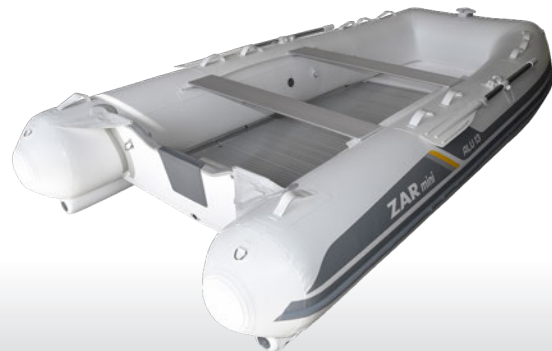

CE



ALU 13

390 cm  
(12' 10")

288 cm  
(9' 5")

195 cm  
(6' 5")

99 cm  
(3' 3")

48 cm  
(19")

ca. 53 + 40 kg\*  
(117 + 88 Lbs\*)

800 kg  
(1760 Lbs)

8

3 + 1

max  
29,4kw (40HP)

rec.  
18,4kw (25HP)

max  
98 kg  
217 Lbs

155x64x35 cm + 132x64x17 cm  
61"x25"x14" + 52"x25"x7"

ALU 14

420 cm  
(13' 10")

312 cm  
(10' 3")

195 cm  
(6' 5")

99 cm  
(3' 3")

48 cm  
(19")

ca. 57 + 43 kg\*  
(125 + 95 Lbs\*)

850 kg  
(1870 Lbs)

8

3 + 1

max  
29,4kw (40HP)

rec.  
22,1kw (30HP)

max  
98 kg  
217 Lbs

155x69x40 cm + 132x64x17 cm  
61"x27"x16" + 52"x25"x7"

ALU 15

460 cm  
(15' 2")

350 cm  
(11' 6")

216 cm  
(7' 1")

112 cm  
(3' 8")

52 cm  
(21")

ca. 70 + 53 kg\*  
(154 + 117 Lbs\*)

1000 kg  
(2200 Lbs)

10

6 + 1

max  
29,4kw (40HP)

rec.  
22,1kw (30HP)

max  
98 kg  
217 Lbs

166x70x42 cm + 141x72x18 cm  
65"x28"x17" + 56"x28"x7"

# FUN 6 • FUN 7 • FUN 8



CE



	Length	Width	Depth	Width at stern	Width at bow	Weight	Weight (+kg)	Person	O <sub>2</sub>	max Outboard	rec. Outboard	max Weight	Storage
<b>FUN 6</b>	180 cm (5' 11")	107 cm (4' 7")	145 cm (4' 9")	69 cm (2' 3")	38 cm (15")	ca. 20 kg* (44 Lbs*)	200 kg (441 Lbs)	2	3	max 2,9kw (4HP)	rec. 2,2kw (3HP)	max 25 kg (55 Lbs)	115 x 55 x 35 cm 45"x22"x14"
<b>FUN 7</b>	210 cm (6' 11")	139 cm (4' 7")	145 cm (4' 9")	69 cm (2' 3")	38 cm (15")	ca. 25 kg* (55 Lbs*)	300 kg (661 Lbs)	2	3	max 2,9kw (4HP)	rec. 2,2kw (3HP)	max 25 kg (55 Lbs)	115 x 55 x 35 cm 45"x22"x14"
<b>FUN 8</b>	240 cm (7' 11")	167 cm (5' 6")	145 cm (4' 9")	69 cm (2' 3")	38 cm (15")	ca. 30 kg* (67 Lbs*)	350 kg (771 Lbs)	3	3	max 3,7kw (5HP)	rec. 2,9kw (4HP)	max 30 kg (67 Lbs)	115 x 55 x 35 cm 45"x22"x14"



# Accessories



C1



C2



C3



C4



S1



S2



S3



S4



SC1



SC2

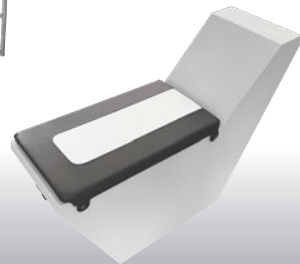

SC3

A man and a woman are enjoying a ride in a white inflatable boat with blue stripes, moving across clear blue water. The man is wearing a pink shirt and purple shorts, and the woman is wearing a red bikini top and a yellow skirt. The boat has a black outboard motor at the back. The text 'ZAR mini' is visible on the side of the boat. In the top right corner, the brand name 'ZAR mini' is displayed in large, bold, black letters on a white background.

# ZAR mini

A brand of **MS**  
MARINE

MS Marine GmbH

Gewerbegebiet Ost 31  
92353 Postbauer-Heng - Germany

Tel. +49 (0) 9188 - 307 98 96

Fax +49 (0) 9188 - 307 98 97

Email [sales@zarmini.com](mailto:sales@zarmini.com)

Web [www.zarmini.com](http://www.zarmini.com)

\* ca. +/- 20% | Technical data and equipment might change without prior notice! Hypalon boats are heavier! | Technische Daten und Ausstattung können ohne Absprache geändert werden! Hypalon Boote sind schwerer!